

Vorder-Ansicht

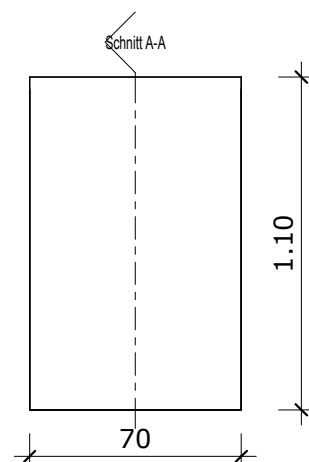

Seiten-Ansicht

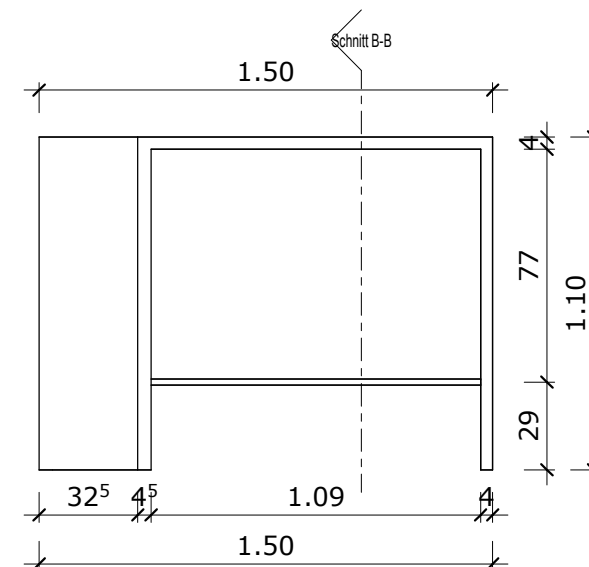

Rück-Ansicht

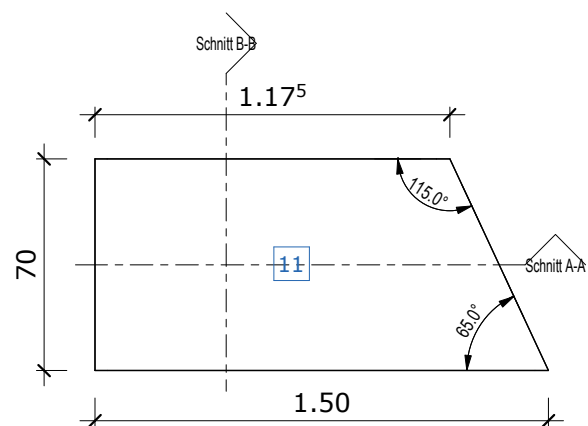

Grundriss

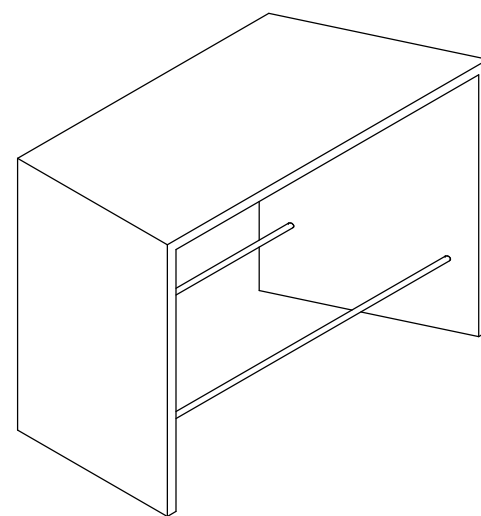

Perspektive Vorder-Ansicht

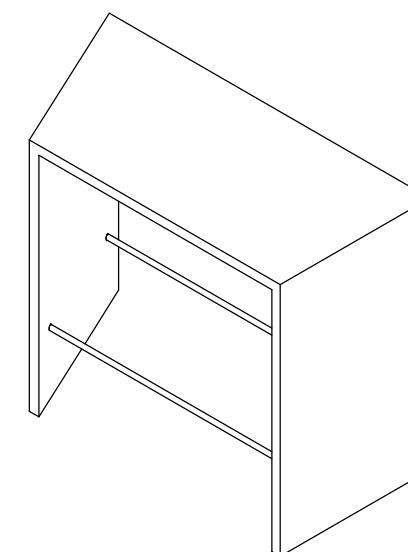

Perspektive Rück-Ansicht

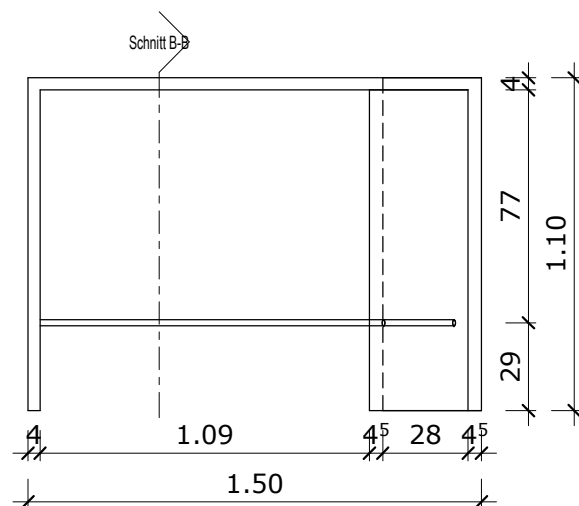

Schnitt A-A

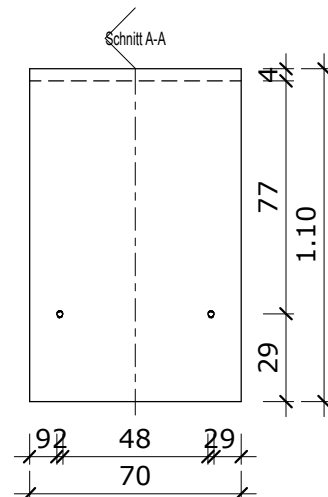

Schnitt B-B

Index	Datum	Name	Änderungen
00			Beginn der Leistungsphase
Otto-Pankok-Schule			
Tisch 11 - Grundriss, Ansichten, Schnitte 1 : 25			
gez. NW	Datum 12.12.2022	Projektnummer MH-GOP-M22	Plannummer D_Tisch11